

Dispensers



APPLICATION:

This Stainless Steel Hands-Free Hand Sanitizer Dispenser is designed to be used in food preparation & medical facilities. The Hands-Free design eliminates cross-contamination and this dispenser is suitable for wet or dry environments.

MATERIAL CONSTRUCTION:

Our free standing foot operated Hand Sanitizer Dispenser is constructed from heavy gauge T-304 Stainless Steel. Holds a 1 gallon pump style container of your favorite hand sanitizing liquid (not included). Features two-position bottle height adjustment. This unit will arrive fully assembled - ready to use.



Model shown: SN101027

APPLICATION:

Our Stainless Steel Wall Mount Holder is used for dispensing soaps or liquids. Designed to mount to a vertical wall (hardware not included) and can be used in wet or dry environments.

MATERIAL CONSTRUCTION:

Constructed from heavy gauge T-304 Stainless Steel. This unit holds a 1 gallon pump style container of your favorite hand soap or liquid (not included). Unit is fully welded and easy to clean. Ships fully assembled - ready to use.

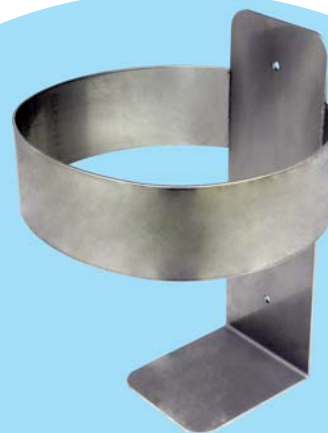

Model shown: HL101002

Manufactured by:

DC TECH INC.

619 E 19th Street
Kansas City, MO 64108-1743

Toll Free: 877-742-9090
Fax: 816-842-4121
www.dctech-inc.com
sales@dctech-inc.com

Note: You may print this with your company name and address as "Distributed By:" in place of our information above. See the PDF logo at the bottom of each page on our website.

HL101002

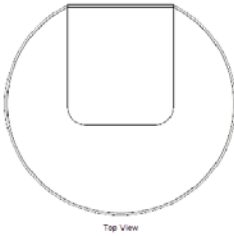

Top View

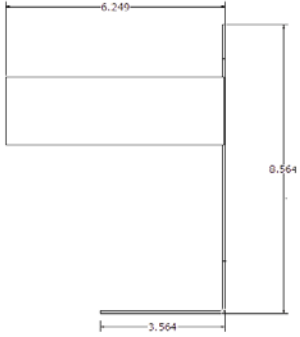
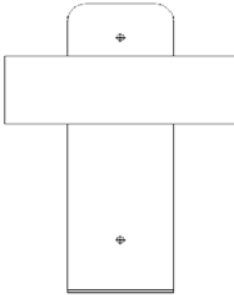
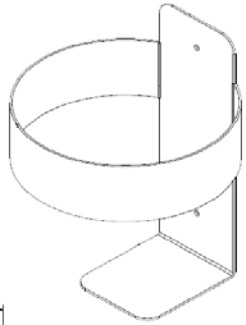

SN101027

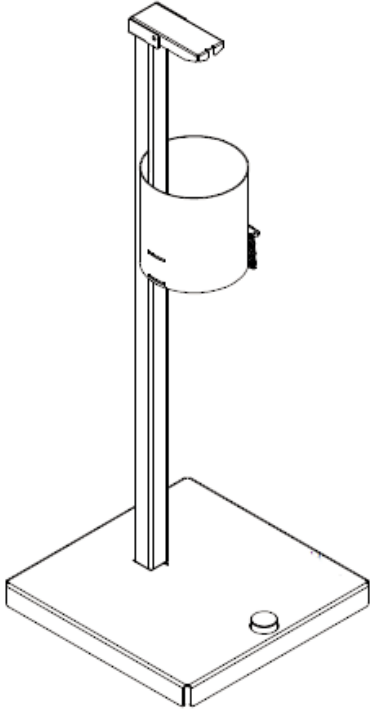
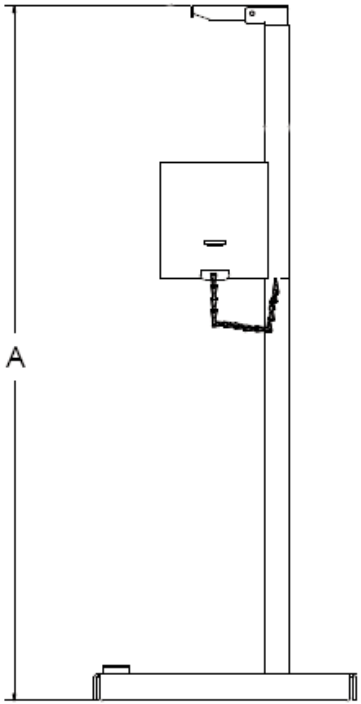
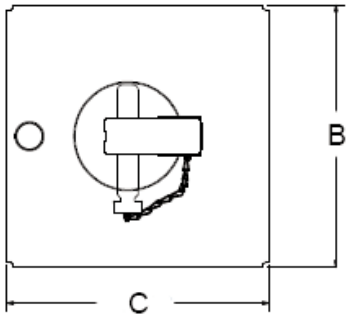

Item # _____

Model #	Description	"A" Height	"B" Width	"C" Depth
SN101027	Hands-Free Dispenser	42.1"	15.9"	15.9"
HL101002	Wall mount Holder	8.56"	6.25"	6.25"

Qty: _____

Job: _____

Manufactured by:

DC TECH INC.

619 E 19th Street
Kansas City, MO 64108-1743

Toll Free: 877-742-9090
Fax: 816-842-4121
www.dctech-inc.com
sales@dctech-inc.com